



Nu-Vista PAM & Nu-Vista PAM PSU

Fully balanced, discrete mono power amplifier with legendary Musical Fidelity Class-A Nu-Vista stage and separate Power Supply Unit

Nu-Vista PAM & PAM PSU In Brief

Amplifier

- Monoblock bridged, balanced & discrete power amplifier
- High output power, greater than 600W into 8 ohms, 1000W into 4 ohms, 1500W peaks into 2 ohms
- Low Noise Nu-Vista circuitry
- 4 x 6S 51N Nuvistors in balanced buffer input circuit
- Signal to noise ratio better than 108dB
- Frequency response 5Hz to 50kHz +0, -1dB
- THD 0.003%, 20Hz – 20kHz

In & Output

- 4 Fully independent inputs (2x RCA & 2x XLR)
- Fully balanced circuitry on XLR inputs

Features

- Dedicated external Nu-Vista PAM PSU
- Colour display with optional VU-Meters and clear selected input
- Dimmable display

MUSICAL FIDELITY

Based on our excellent Nu-Vista 800 circuit we decided to go all out “fully balanced” on the Nu-Vista range.

The Nu-Vista PAM features the tried and tested Nu-Vista stage featuring 6S51N nuvistors in a discrete class A amplifier buffer.

Technical Talk

This is followed by a balanced configuration circuit and balanced input high power, low distortion “bridged” output amplifier stage. The power stages have 2x 5 pairs of high power thermally compensated output devices for reliable and stable operation.

Based on the Titan 1000W stage, it has separate capacitors

for bulk supply, and one each for output device, reducing output impedance and improving dynamics. Chokes are added for further improved supply ripple and pulse current spike reduction. Bias is set for over 5W of initial class A operation thereafter the stage slides into class B operation at a point where the now much lower discontinuity is easier dealt with than “standard” crossover distortion.



MUSICAL FIDELITY

Nu-Vista PAM PSU

The Nu-Vista PAM comes with its own dedicated external power supply.

To achieve better noise performance, we removed the AC mains power supply from

the main unit and built it into another matching box. In this box we took advantage the extra space to set up inbuilt mains and output filtering. This quiets up the supplies and results in almost no mains-borne artefacts getting into the sensitive audio circuitry.

The Power supply has ON/Standby LEDs and is controlled from the main unit front panel. If total mains isolation is required, the power supply also has rear mounted mechanical rocker switch for full power off.



MUSICAL FIDELITY



Heroic Build Quality

The Nu-Vista PAM's mechanical construction is uncompromisingly rigid and solid in typical Musical Fidelity tradition. Front panel and side panels are milled from extruded aluminium profiles and are extremely massive.

The separate Nu-Vista PAM PSU houses all the transformers, which by nature generate mechanical vibrations and radiate harmful electromagnetic fields. Here they are as far away as possible from the critical amplifier circuits. This significantly contributes to great signal to noise ratio. We basically get immunity against the effects of vibrati-

on from the environment. The same can be said about electro magnetic immunity.

The massive aluminium case acts as a Faraday cage. It protects the internals against outer electromagnetic fields, and in the same way, the rest of your hi-fi gear against electromagnetic fields generated by the Nu-Vista PAM.





The Legendary Nu-Vista Stage

Never before in the history of hi-fi have Nuvistor tubes been coupled with state-of-the-art fully balanced and discrete technology and sophisticated modern design techniques. The Nu-Vista PAM & Nu-Vista PAM PSU's technical performances are astonishing. They measure like a dream but, more importantly, sound incredible. Silky smooth with enormous transients and an effortless feel that is at once relaxing and involving. Of special note how they project images between the loudspeakers so that you can almost touch them.

The new Nu-Vista PAM and its PSU were a continued labour of love for Musical Fidelity. We are passionate about what we do and passionate about Nuvistor tubes as we have always been. We hope that you derive as much pleasure listening to the Nu-Vista PAM as we had creating it.





Nuvistor tubes

Nuvistor tubes were invented in the 1950s to solve the many shortcomings of conventional tubes. Unlike them, Nuvistor tubes offer very high reliability, low microphony, low noise, consistency from batch to batch, small size, relatively low power consumption and great technical performance.

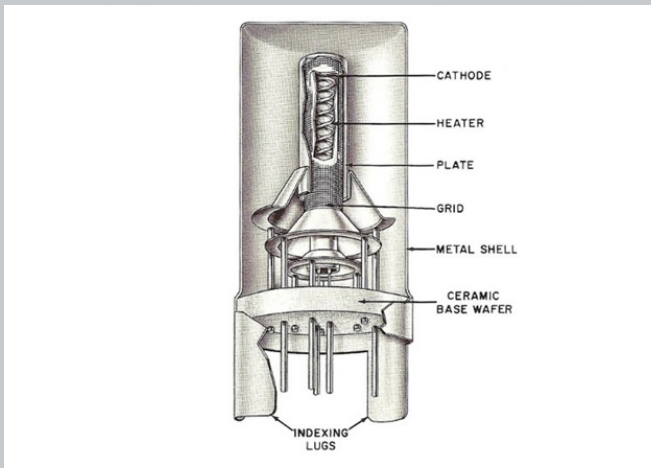

One famous application was in the Ampex MR-70, a costly studio tape recorder whose entire electronics section was based on nuvistors. Another limited application of this very small tube was in studio-grade microphones from that era, the AKG/Norelco C12a, which employed the 7586, being a good example.

It was also later found in the famed Neumann U 47 studio microphone. This microphone was highly regarded by artists all over the world, and was used by many top recording artists such as Frank Sinatra, The Beatles, and so on. Remarkably, you can currently see a U47 microphone, with its stand, cables and power supply on eBay for \$10.999 „Buy-it-now“.

Unfortunately just as uses for Nuvistor tubes were being explored, the transistor was invented and it was 'game over' for Nuvistors. There the matter rested until about fifteen years ago, when Musical Fidelity created the first of its ground-breaking Nu-Vista series. These legendary, limited-edition products sold out in a matter of months. Today, fifteen years later, they command very high secondhand prices because of their beautiful sound, build quality, and longevity.





Specifications

Amplifier

- High output power, greater than 600W into 8 ohms, 1000W into 4 ohms, 1500W peaks into 2 ohms
- Output Voltage: 69 Volts RMS
- Output Current: 150 Amps peak to peak
- Damping factor: 180
- Output devices: 5+5 pairs per channel
- Gain: 16x (23.5 dB)
- THD+N: < 0.003 % typical, 20Hz to 20 kHz
- Signal / noise ratio: >108dB 'A'-weighted
- Input impedance: 100 k Ohms
- Input sensitivity for full output: 4.3 Volts RMS
- Frequency response: + 0, -1dB, 5Hz to 50 kHz

In & Output

- 4 fully independent inputs: 2x RCA & 2x XLR
- 2 loop through outputs: 1x RCA & 1x XLR
- Speaker outputs: 2 pairs 4mm banana plug/binding posts
- Trigger input and output: 3.5mm mono jack socket
- Trigger level $\pm 5V$ to $\pm 12V$

General Information

- Weight PAM: 27kg net (35kg)
- Weight PAM PSU: 40kg net (50kg)
- Dimensions PAM (WxHxD): 483 x 187,5 x 475 (494 with connectors)
- Dimensions PAM PSU (WxHxD): 483 x 187,5 x 475 (478 with connectors)
- Mains voltages: 115/230VAC 50/60Hz (factory pre-set); 100VAC 50/60Hz (alternative)
- Consumption <0.5W in standby mode; 130W on and idle; 2150W maximum